

Article number: 03550060

Description: Fluro hydraulic rod end FPR 60S

## Measures

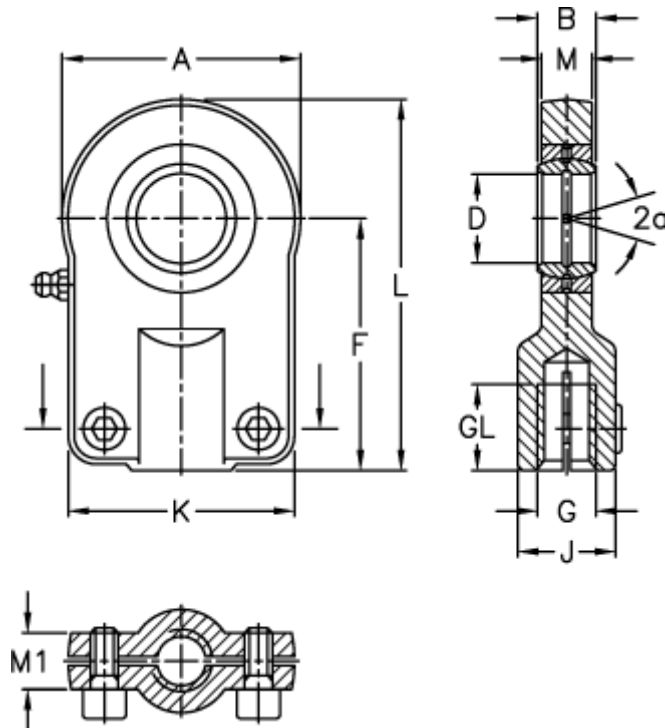

A	= 160	J	= 68
a (degrees)	= 6	K	= 134
B	= 44	L	= 230
D	= 60	M	= 38
Dynamic load C (kN)	= 245	M1	= 38
F	= 150	Static load C0 (kN)	= 380
g	= M42x2	Torque (N m)	= 210
GL	= 57	Weight	= 8400